

131TA001C1

**TOYOTA SUPRA
A90**

ASP

ADJUSTABLE SPRING PERCH

BC



Thank you for purchasing the BC Racing A.S.P.
Please read this instruction guide carefully before proceeding with install.

BC Part Number	131TA001C1
Vehicle	TOYOTA SUPRA
Model/Chassis	A90
Year	2019+
Min. Ride Height from OEM	FRONT -33mm
	REAR -34mm
TIRE SIZE FRONT	255/35/19
TIRE SIZE REAR	275/35/19

▲ All vehicle lowering data is for reference only and may vary depending on individual vehicle conditions.

Disclaimer

The BC Racing ASP is designed and intended to lower a vehicle's ride height. The use of this product on public roadways may not meet local, state, or federal regulations. Installation and use of this product may affect the vehicle's original manufacturer's warranty. It is the consumer's responsibility to meet and comply with federal, state, or local government regulations and/or policies prior to operating the vehicle on public roadways.







ATTENTION!!

Removal of OEM components from damper assemblies and installation of this product may only be undertaken by trained technical personnel with ASE certification.

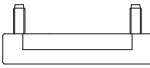
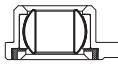



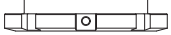
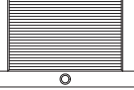

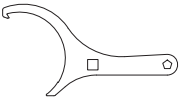

Incorrect installation/adjustment can damage OEM Dampers or other OEM components, which we are not able to supply. Installers shall be responsible for any damage due to incorrect installation or adjustment.

Parts List

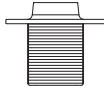
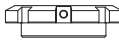
FRONT

SA13-0044-1		TOP NUT	2
SAAC-0029		CAMBER PLATE	2
SA02-1024		CAMBER BEARING HOUSING	2
SA09-0020-1		UPPER SPRING SEAT	2
SA11-0031-22		BUMPSTOP	2
1-SPS-2253.5-A1		SPRING	2
SG09-1108		LOCKING RING	2
SG07-2221		SPRING PERCH	2
SA15-6004		M6 SET SCREW	2
SA15-6002		M5 SET SCREW	6
SG12-0079		SPANNER	1

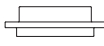
REAR

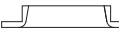
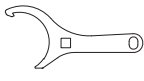
SA11-2019		DUST COVER	2
SA11-0030-18		BUMPSTOP	2
SA05-1041		UPPER RUBBER PAD	2
SG07-2216		SPRING PERCH	2
SG09-1104		LOCKING RING	2
SA15-6004		M6 SET SCREW	2
SA05-2002		INSULATOR	2
1-SP-24009-A1		SPRING	2
SA09-1216		SPRING ADAPTOR	2
1-SP-0680.45-A1		HELPER SPRING	2
SA09-1217		HELPER SPRING SEAT	2
SA05-1011		BOTTOM RUBBER PAD	2
SG12-0066		SPANNER	1

Before Installation



CAUTION

- This product was designed and developed for specific vehicle models and should only be installed on the intended application. Ensure you received the correct items for your vehicle before attempting installation.
- No part of this instruction may be reproduced or transmitted in any form or by any means, electronic or mechanical, including photocopying, recording, or by any information storage and retrieval system, without express written permission from Taiwan Bor-Chuann Enterprise Co., Ltd.
- **This product may only be installed by trained technical personnel with ASE certification.**
- Do not use impact wrenches to install or remove damper/shock absorber hardware.
- Installation and removal of suspension components including dampers and springs must be in accordance with the original manufacturer's specifications. Please refer to the factory service manual if available.
- BC (Taiwan Bor-Chuann Enterprise Co., Ltd) is not liable for any damages and/or failures caused by the use of components not supplied by BC (Taiwan Bor-Chuann Enterprise Co., Ltd).
- Incorrect installation or adjustment can cause noise and/or damage to the product, which will not be covered by warranty.

ARROW INDICATION

- INSTRUCTION
- BC SUPPLIED ASP PARTS
- OEM PARTS

Installation FRONT

1

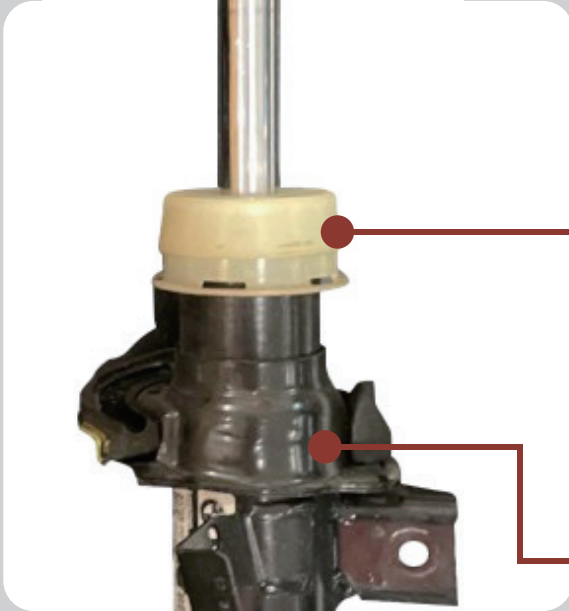

Remove the OEM top mount, spring, dust cover, bump stop, damper cap, and the spring seat. Clean the damper especially the area where the adjustable spring perch rests.

OEM damper cap

OEM spring seat

2

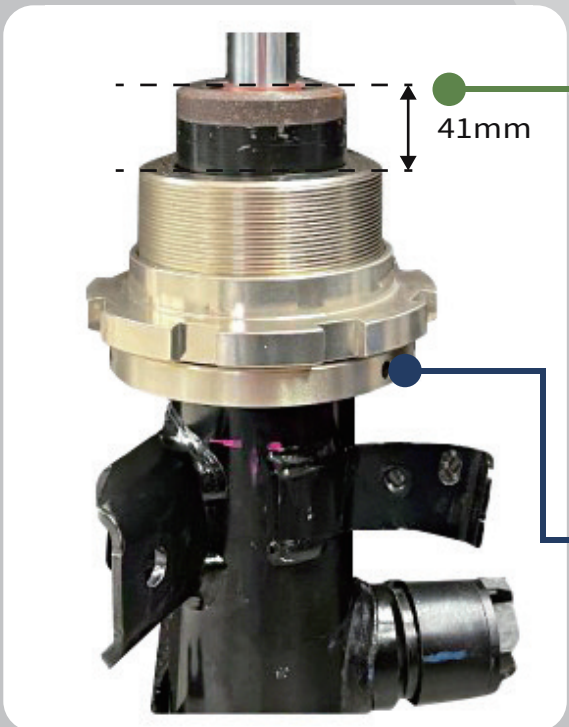

Loosen the three M5 set screws and then slide the adjustable spring perch all the way down till it gets stuck and can not go any lower. It is around 41mm measured from the top edge of the OEM damper body to the adjustable spring perch. Tighten the three M5 set screws after installation of the spring perch. (Always use a rubber mallet when installing the spring perch to the required depth.)

M5 set Screw x3

3

Tighten the M6 set screw on the side of locking ring after installation.

4



③



②



①



Install the following parts in order :

1.OEM damper cap



2.BC ASP bump stop



3.BC ASP coil spring

5

Install the following parts in order :

1.OEM dust cover



2.OEM strut bearing



3.BC ASP upper spring seat



4.BC ASP camber plate



5.BC ASP top nut

(M12, with 50Nm of torque)



Installation REAR

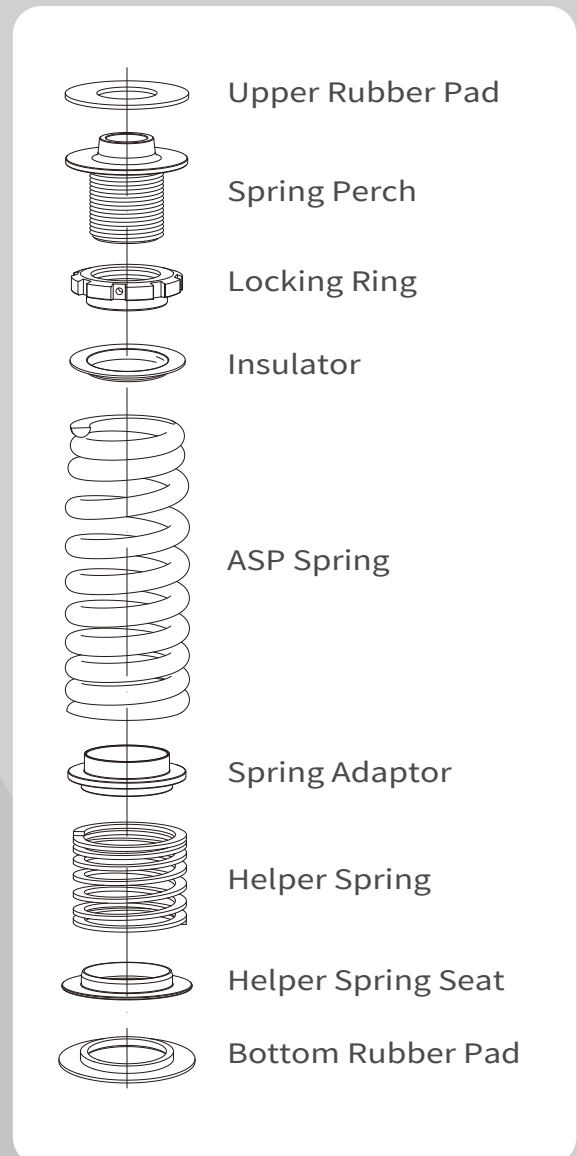
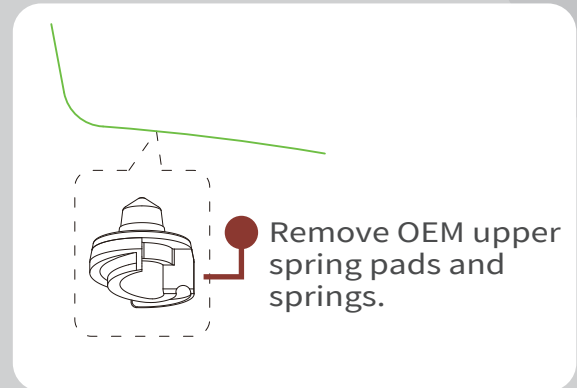
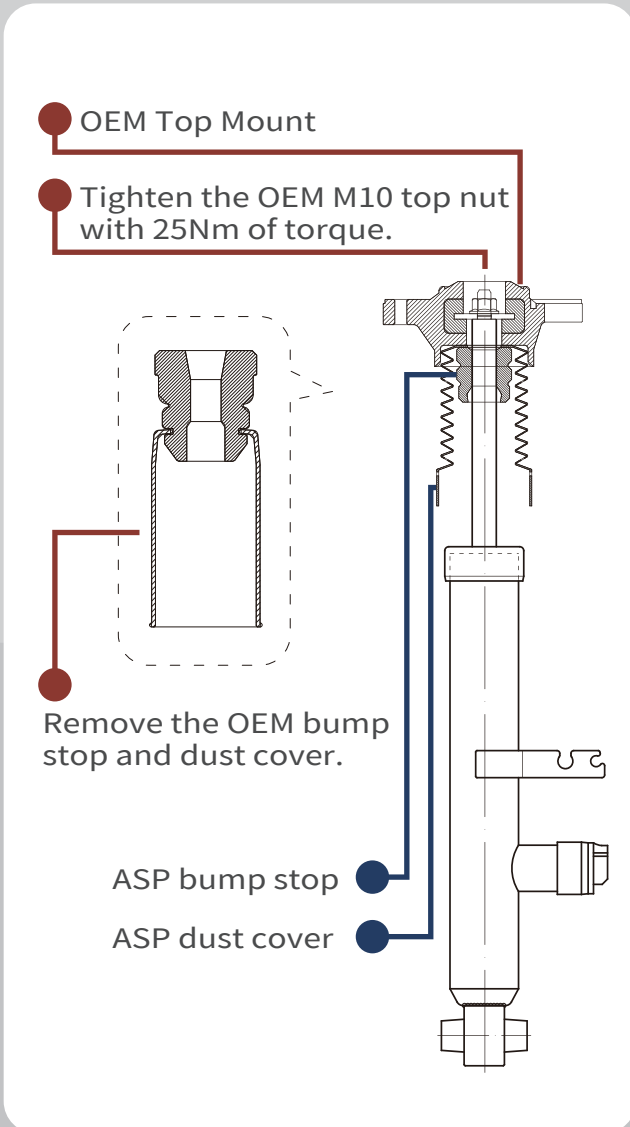

6

Install the BC supplied ASP parts and springs in the order shown on the right-hand side.



- Do not over tighten damper top nuts. All hardware should be tightened in accordance with the recommended torque values specified in the vehicle manufacturer's manual.

Adjustment

- Do not over tighten the spring as this will compress spring and cause rate shifting.
- Always clean dirt and debris from threads with pressurized air and/or brake cleaner. It is recommended to grease adjuster threads before performing ride height adjustments to prevent locking rings from seizing.

After Installation

- Make sure all hardware that was removed during installation are properly tightened.
- Ensure the set screw on each locking ring is tightened.
- A full vehicle alignment is highly recommended after installation, as it greatly influences the vehicle's handling characteristics and tire wear.
- Perform regular periodic checks on all hardware and locking rings.

Technical Support

- Please keep the original purchase invoice and warranty card for future service requests.
- Lowering your vehicle will change chassis suspension geometry. This can lead OEM components such as control arms, to generate noise. Relative age and condition of the surrounding suspension components may exacerbate noise production, commonly referred to NVH (noise, vibration, harshness).
- Please contact your local distributor for more information concerning technical support or advice concerning the product.

ASP

ADJUSTABLE SPRING PERCH

BC



 bc@bcec.com.tw

 www.bcec.com.tw